



# HART® Interface Manual

**“KT” Series Magnetostrictive**

**Liquid Level Transmitters**



**Kenco Engineering Company**

10001 East 54th Street

Tulsa, Oklahoma 74146

Phone: 918-663-4406

Fax: 918-663-4480

Website: [www.kenco-eng.com](http://www.kenco-eng.com)

Email: [info@kenco-eng.com](mailto:info@kenco-eng.com)

## Table of contents

<b>1. Terms and definitions</b> .....	<b>3</b>
<b>2. Introduction</b> .....	<b>5</b>
2.1 Purpose and use of this manual .....	5
2.2 Used symbols and warnings .....	5
<b>3. Safety instructions</b> .....	<b>5</b>
3.1 Intended use.....	5
<b>4. Product overview</b> .....	<b>5</b>
4.1 Before you begin .....	5
4.2 Quick start-up procedure.....	5
<b>5. Display Menu</b> .....	<b>5</b>
5.1 Operation Modes .....	6
5.2 Display Diagram .....	6
5.3 Menu Structure .....	7
<b>6. Alarms</b> .....	<b>7</b>
6.1 Software Fault Alarm .....	7
6.2 Hardware Fault Alarm .....	7
<b>7. Alarms</b> .....	<b>8</b>
<b>8. HART® Interface</b> .....	<b>9</b>
8.1 Dashboard.....	9
8.2 Handheld Programming .....	13

## 1. Terms and definitions

### 6A Heavy Oils

'Generalized Crude Oils', Correction of Volume to 60 °F against API Gravity.

### 6B Light Oils

'Generalized Products', Correction of Volume to 60 °F against API Gravity.

### 6C Chemical

'Volume Correction Factors (VCF)' for individual and special applications, volume correction to 60 °F against thermal expansion coefficients.

### 6C Mod

An adjustable temperature reference for defining VCF.

## A

### API gravity

The measure of how heavy or light a petroleum liquid is compared to water. Allowable values are 0 to 100 degrees *API* for (6A) and 0 to 85 degrees *API* for (6B).

## D

### DDA (Direct Digital Access)

The digital protocol developed for use in intrinsically safe areas.

### Density

Mass divided by the volume of an object at a specific temperature. The density value should be entered as lb / cu. ft..

## E

### Explosion proof

Type of protection based on enclosure in which the parts which can ignite an explosive gas atmosphere are placed within, and which can withstand the pressure developed during an internal explosion of an explosive mixture, and which prevents the transmission of the explosion to the explosive gas atmosphere surrounding the enclosure.

## F

### Flameproof

Type of protection based on enclosure in which the parts which can ignite an explosive gas atmosphere are placed within and which can withstand the pressure developed during an internal explosion of an explosive mixture, and which prevents the transmission of the explosion to the explosive gas atmosphere surrounding the enclosure.

## G

### GOVI (Gross Observed Volume of the Interface)

The total volume of the tank occupied by the interface liquid. The *GOVI* is only given when measuring two liquids and is calculated by subtracting the volume of the product from the total volume of liquid in the tank (*GOVT* – *GOVP*).

### GOVP (Gross Observed Volume of the Product)

The total volume of the tank occupied by the product liquid. When measuring only one liquid, it is also the total volume of liquid in the tank (*GOVT*). When measuring two liquids it is the total volume of liquid in the tank minus the volume of the interface liquid (*GOVT* – *GOVI*).

### GOVT (Total Gross Observed Volume)

The total volume of liquid in the tank. When measuring only one liquid it is equal to the volume of the product (*GOVP*). When measuring two liquids it is equal to the volume of the product and interface liquids (*GOVP* + *GOVI*).

### GOVU (Gross Observed Volume Ullage)

The difference in volume between the working capacity of a tank and the total volume in the tank (Working Capacity – *GOVT*).

## H

### HART®

A *Bidirectional communication protocol* that provides data access between intelligent field instruments and host systems.

## I

### Interface

*Noun*; The measurement of the level of one liquid when that liquid is below another liquid.

### Interface

*Adj.*; The Software *Graphical User Interface* (GUI) that allows the user to access software protocols (*HART*®, *DDA*, *MODBUS*).

### Intrinsic safety

'Intrinsically safe' - Type of protection based on the restriction of electrical energy within apparatus of interconnecting wiring exposed to potentially explosive atmosphere to a level below that which can cause ignition by either sparking or heating effects.

## L

### LRV - Lower Range Value

Parameter in HART for controlling where the 4 mA set point.

**M****Mass**

The property of a body that causes it to have weight in a gravitational field, calculated by density at the reference temperature multiplied by the volume correction factor ( $Density \times VCF$ ).

**MODBUS**

A *serial communications protocol* published by Modicon in 1979 for use with its programmable logic controllers (PLCs). It has become a de facto standard communications protocol in industry, and is now the most commonly available means of connecting industrial electronic devices.

**N****NEMA Type 4X**

A product *Enclosure* intended for indoor or outdoor use primarily to provide a degree of protection against corrosion, windblown dust and rain, splashing water, and hose-directed water; and to be undamaged by the formation of ice on the enclosure. They are not intended to provide protection against conditions such as internal condensation or internal icing.

**NPT**

*U.S. standard* defining tapered pipe threads used to join pipes and fittings.

**NSVP (Net Standard Volume of the Product)**

The temperature corrected volume for the product liquid in the tank, requires the transmitter to be ordered with temperature measurement capabilities. The *NSVP* is calculated by multiplying the volume of the product liquid by a volume correction factor based on temperature ( $GOVP \times VCF$ ).

**P****PV - Primary Variable**

First variable in HART® that is communicated. PV is set to Loop 1 (Product Level) by default. For SIL 2 capable units Loop 1 cannot be changed from PV.

**R****Reference Temperature**

The *temperature* at which the density measurement is given, the allowable values are 32 °F to 150 °F (0 °C to 66 °C).

**S****Specific Gravity**

The *density ratio* of a liquid to the density of water at the same conditions.

**Sphere Radius**

The *internal radius* of the sphere that contains the liquid, the value is used to calculate the volume along with the *Sphere Offset*.

**Sphere Offset**

An *offset value* that accounts for additional volume in a sphere from non-uniform sphere geometry, the value is used to calculate the volume along with the *Sphere Radius*.

**Strap Table**

A *table of measurement* correlating the height of a vessel to the volume that is contained at that height. The transmitter can contain up to 100 points.

**SV - Secondary Variable**

Second variable in HART® that is communicated. SV is set to Loop 2 (Interface Level) by default unless temperature is ordered and the temperature is default.

**T****TEC**

'Thermal Expansion Coefficient' - a value correlating the change in temperature for an object with the change in its volume. Allowable values are 270.0 to 930.0. TEC units are in 10 E-6/Deg F.

**Temperature Correction Method**

One of five *product correction methods* used to correct the product volume in the tank due to changes in temperature from 60 °F including (6A, 6B, 6C, 6C Mod, and Custom Table).

**TV - Tertiary Variable**

Third variable in HART® that is communicated. TV is set to temperature by default.

**U****URV - Upper Range Value**

Parameter in HART® for controlling where the 20 mA set point.

**V****Volume Calculation Mode**

One of two methods use to calculate volume measurements from level measurements, including *Sphere* and *Strap Table*.

**VCF (Volume Correction Factor)**

A table of measurements correlating temperature points with correction factors for the liquids expansion/contraction. The transmitter can contain up to 50 points.

**W****Working Capacity**

The *maximum volume of liquid* that the user desires for their vessel to hold, typically 80 % of the vessels maximum volume before overflow.

## 2. Introduction

### 2.1 Purpose and use of this manual

**Important:**

Before starting the operation of the equipment read this documentation thoroughly and follow the safety information.

The content of this technical documentation and of its various annexes is intended to provide information on the HART® Interface of the transmitter. All safety related information is in the product specific operation manual.

### 2.2 Used symbols and warnings

Warnings are intended for your personal safety and for avoidance of damage to the described product or connected devices. In this documentation, safety information and warnings to avoid dangers that might affect the life and health of personnel or cause material damage are highlighted by the preceding pictogram, which is defined below.

Symbol	Meaning
<b>NOTICE</b>	This symbol is used to point to situations that may lead to material damage and/or personal injury.

## 3. Safety instructions

### 3.1 Intended use

The purpose of this document is to provide detailed information on the protocol interface. All safety related information is in the product specific operation manual. Consult the operation manual before connecting to the level transmitter.

## 4. Product overview

### 4.1 Before you begin

**NOTICE**

Output will vary depending on the location of the 4 and 20 mA set points.

**Tools needed:**

- 24 Vdc linear regulated power supply
- Current meter

### 4.2 Quick start-up procedure

1. Connect 24 Vdc power supply to Loop 1.
2. Turn on power supply.
3. Connect Current Meter to test pins on interconnect board. Loop 1 Test Pins are on the bottom left and labeled TP1 and TP2.
4. Move the float towards the tip of the pipe and verify 4 mA set point.
5. Move the float towards the top of the pipe and verify 20 mA set point.
6. If using two floats, repeat steps 4 and 5 for second float. Test pins for Loop 2 are TP5 and TP6. Note both floats must be present or else the level transmitter will go into alarm.
7. Turn off power and disconnect power supply and current meter.
8. Install in tank.

## 5. Display Menu

All liquid level transmitters are shipped with a Stylus (Kenco Part # 79857) to be used for manipulating the display. For single and dual cavity housings, the Stylus is designed to allow for programming of the unit without removing the housing. When using the Stylus make sure to align the Stylus with the shape outline around the buttons in the same orientation. Failure to correctly align the Stylus can cause the display to not function properly.

**NOTICE**

Do not use any device other than the Stylus to operate the display.

**NOTICE**

Improper use of the Stylus can cause the display to not function properly.

### 5.1 Operation Modes

The level transmitter runs in one of the following modes of operation. You can use these modes to calibrate and set up various operating parameters.

#### 5.1.1 Run Mode

Run mode is the primary mode of operation. This mode will perform measurements, display data, and respond to HART® commands.

#### 5.1.2 Program Mode

Program mode is the primary mode for commissioning and troubleshooting the level transmitter. The full menu and available functions are shown in section 5.3 Menu Structure. To enter program mode use the Stylus and press the Enter Key as shown in section 5.2 Display Diagram. Program Mode is protected by a password to keep unwarranted changes from occurring.

**NOTICE**

The factory default password is 27513.

When in program mode, remote communications are not functional. An automatic timeout feature is provided so that the transmitter does not remain inadvertently in program mode. The timeout is set for 1 minute before prompted for additional time. Total timeout is 2 minutes.

**NOTICE**

Whenever program mode is exited from the display the unit will reset itself to insure all changes have been accepted. The reset will take approximately 5 seconds before the level transmitter is able to respond to commands.

**NOTICE**

In program mode, the transmitter will not respond to incoming HART® commands. A busy error will be sent to the controller to notify the unit is in program mode. This function will prevent a user at a remote terminal from programming the unit while a user is accessing program mode from the display.

### 5.2 Display Diagram

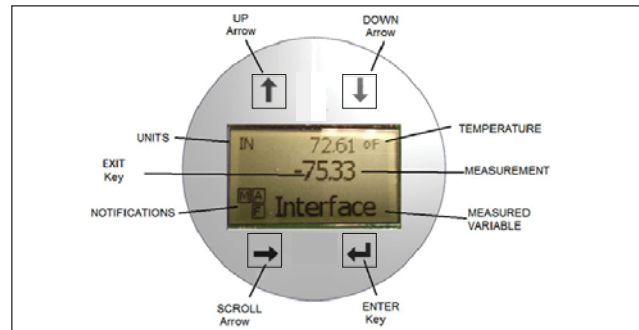

Fig. 1: Display

Key / Element	Function
<b>UP Arrow</b>	Used to move cursor on screen up and to increment number
<b>DOWN Arrow</b>	Used to move cursor on screen down and to decrease number
<b>SCROLL Arrow</b>	Used to move cursor on screen to the right, cursor will cycle back
<b>ENTER Key</b>	Used to Enter Program Mode, select Highlighted Item, and Confirm Selection
<b>EXIT Key</b>	Hidden key in the middle of the display that is used to exit menu at any time
<b>MEASURED VARIABLE</b>	The process variable that is selected to display. The display will automatically scroll between selected variables.
<b>MEASUREMENT</b>	The numerical value for the MEASURED VARIABLE shown on the display.
<b>UNITS</b>	Unit of measurement for the MEASURED VARIABLE shown on the display.
<b>TEMPERATURE</b>	Average temperature for the product in the tank. Only shown if the level transmitter was purchased with temperature.
<b>NOTIFICATIONS</b>	Four squares with letters. Top left square is blank. Top right square, A, will only show when there is an alarm. Toggle the UP Arrow key to view alarms. Bottom right square, F, will only show when there is a fault. Toggle the DOWN Arrow key to view error codes. Bottom left square, P, will only show when the units is being programmed remotely.

### 5.3 Menu Structure

#### Data From Device

- Display
- Units
  - Length Units
  - Temp Units
- Set Points
  - Prod LVR (4 mA)
  - Prd URV (20 mA)
  - Prd Current LRV
  - Prd Current URV
  - Int LRV (4 mA)
  - Int URV (20 mA)
  - Int Current LRV
  - Int Current URV
- Alarm Select
- Signal Strength
  - Prod Trig Lvl
  - Int Trig Lvl

#### Calibrate

- Product Level
  - Current Level
  - Offset
- Interface Level
  - Current Level
  - Offset

#### Factory

- Settings
  - Gradient
  - Serial Number
  - HW Revision
  - SW Revision
  - SARA Blanking
  - Magnet Blanking
  - Gain
  - Min Trig Level
  - Reverse Measure
- Temp Setup
  - Temp Enable
  - No of Temp
- Float Config
  - Loop 1
  - Loop 2
- Damping
  - Loop 1
  - Loop 2
- Auto Threshold
- Reset to Factory

## 6. Alarms

There are two separate types of alarms featuring both a software fault alarm and a hardware fault alarm.

### 6.1 Software Fault Alarm

Software fault alarm will force the 4...20 mA output into an either a low or high alarm state. The default setting from the factory is a low alarm state. The low alarm state is  $\leq 3.6$  mA and the high alarm state is  $\geq 21$  mA. The software fault alarm follows the recommendations set forth by NAMUR NE 43. Typical faults that will cause a software fault alarm are a missing float, the float in the inactive range, and the level transmitter looking for the wrong number of floats.

### 6.2 Hardware Fault Alarm

Hardware fault alarm will force the 4...20 mA output into a low alarm. The hardware low alarm is 3.2 mA. The hardware low alarm is triggered when the internal diagnostics of the level transmitter have detected a hardware issue with the 4...20 mA output.

## 7. Alarms

Fault Code	Description	Corrective Action
101	Missing Magnet	<ul style="list-style-type: none"> <li>Verify Float Configuration is correct for the number of floats installed.</li> <li>Verify Float(s) are not in inactive zone.</li> <li>Verify Auto Threshold is enabled.</li> <li>Cycle power to sensor. If proper operation is not restored, Contact Factory.</li> </ul>
102	Internal Fault 1	Cycle power to sensor. If proper operation is not restored, Contact Factory.
103	Internal Fault 2	Cycle power to sensor. If proper operation is not restored, Contact Factory.
104	Internal Fault 3	Cycle power to sensor. If proper operation is not restored, Contact Factory.
105	Lobe Fault 1	<ul style="list-style-type: none"> <li>Verify Auto Threshold is enabled.</li> <li>Cycle power to sensor.</li> <li>If proper operation is not restored, Contact Factory.</li> </ul>
106	Lobe Fault 2	<ul style="list-style-type: none"> <li>Verify Auto Threshold is enabled.</li> <li>Cycle power to sensor.</li> <li>If proper operation is not restored, Contact Factory.</li> </ul>
107	Delta Fault	The change in level output exceeded the Delta limit. The Delta can be adjusted if the process is changing quickly or this can be an indication of electrical noise. Check grounding and shielding before adjusting the Delta value.
108	Internal Fault 4	Cycle power to sensor. If proper operation is not restored, Contact Factory.
109	Peak Fault	<ul style="list-style-type: none"> <li>Verify Auto Threshold is enabled.</li> <li>Cycle power to sensor.</li> <li>If proper operation is not restored, Contact Factory.</li> </ul>
110	Hardware Fault 1	Cycle power to sensor. If proper operation is not restored, Contact Factory.
111	Power Fault	<ul style="list-style-type: none"> <li>Cycle power to sensor.</li> <li>Verify Power Supply rating.</li> <li>Verify wiring.</li> <li>If proper operation is not restored, Contact Factory.</li> </ul>
112	Hardware Fault 2	Cycle power to sensor. If proper operation is not restored, Contact Factory.
113	Hardware Fault 3	Cycle power to sensor. If proper operation is not restored, Contact Factory.
114	Hardware Fault 4	Cycle power to sensor. If proper operation is not restored, Contact Factory.
115	Timing Fault 1	Cycle power to sensor. If proper operation is not restored, Contact Factory.
116	Timing Fault 2	Cycle power to sensor. If proper operation is not restored, Contact Factory.
117	Timing Fault 3	Cycle power to sensor. If proper operation is not restored, Contact Factory.

Fault Code	Description	Corrective Action
118	DAC Fault 1	Cycle power to sensor. If proper operation is not restored, Contact Factory.
119	DAC Fault 2	Cycle power to sensor. If proper operation is not restored, Contact Factory.
120	DAC Fault 3	Cycle power to sensor. If proper operation is not restored, Contact Factory.
116	DAC Fault 4	Cycle power to sensor. If proper operation is not restored, Contact Factory.
117	SPI Fault 1	Cycle power to sensor. If proper operation is not restored, Contact Factory.
118	SPI Fault 2	Cycle power to sensor. If proper operation is not restored, Contact Factory.
119	Setpoint Fault	The analog setpoints are too close. Minimum distance is 150 mm (6 in.) for analog and 290 mm (11.5 in.) for SIL. Adjust programmed setpoints as needed. (Analog only) If proper operation is not restored, Contact Factory.
120	Loop 1 Out of Range	Verify that magnets are positioned within expected measuring range. Adjust programmed setpoints as needed. (Analog only) If proper operation is not restored, Contact Factory.
121	Loop 2 Out of Range	Verify that magnets are positioned within expected measuring range. Adjust programmed setpoints as needed. (Analog only) If proper operation is not restored, Contact Factory.
122	EEPROM Fault 1	Cycle power to sensor. If proper operation is not restored, Contact Factory.
123	EEPROM Fault 2	Cycle power to sensor. If proper operation is not restored, Contact Factory.
124	Flash Failure	Cycle power to sensor. If proper operation is not restored, Contact Factory.
125	Internal Error	Cycle power to sensor. If proper operation is not restored, Contact Factory.
126	Loop 2 Out of Range	Verify that magnets are positioned within expected measuring range. Adjust programmed setpoints as needed. (Analog only) If proper operation is not restored, Contact Factory.
127	EEPROM Fault 1	Cycle power to sensor. If proper operation is not restored, Contact Factory.
128	CRC Fault	Reset CRC using Dashboard or Handheld HART Communicator
129	Flash Failure	Cycle power to sensor. If proper operation is not restored, Contact Factory.
130	Internal Error	Cycle power to sensor. If proper operation is not restored, Contact Factory.



## 8. HART® Interface

Factory has tested and is compliant to HART® ITK 7.2. The device driver file is available for download from HART® Communication Protocol website at: [www.hartcomm.org](http://www.hartcomm.org) or from factory website. Programming via HART® can be done either using the Dashboard via a HART® modem or a handheld programmer.

### 8.1 Dashboard

#### 8.1.1 Installing Dashboard

Adjustments to the setup and calibration of the HART® Interface can be performed using the Dashboard. The Dashboard can be run from any Windows 7 or newer OS using a HART® to USB converter.

Perform the following steps to install the Dashboard and establish communication:

1. Install Dashboard from the USB stick that came with the level transmitter or go to factory website to download the latest version.
2. Connect level transmitter to HART® to USB converter, connect 24 Vdc power to the level transmitter, and connect the HART® to USB converter to the PC. Example setup shown below.

#### NOTICE

Power must be on Loop 1 for HART® communication to work. Power does not have to be applied on Loop 2 for HART® to work. Power must be applied to Loop 2 to check current output.

#### NOTICE

HART® requires a load resistor to work correctly. Add a 250 Ohm resistor for proper communication. Some PLC cards will have built in load resistors.

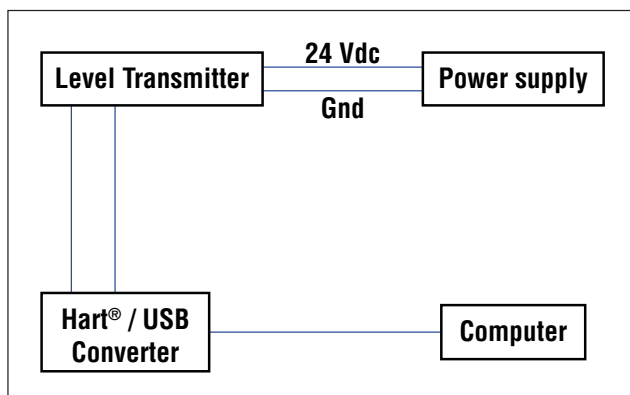

Fig. 2: Example setup

3. Open setup software and select HART® protocol from drop down menu.

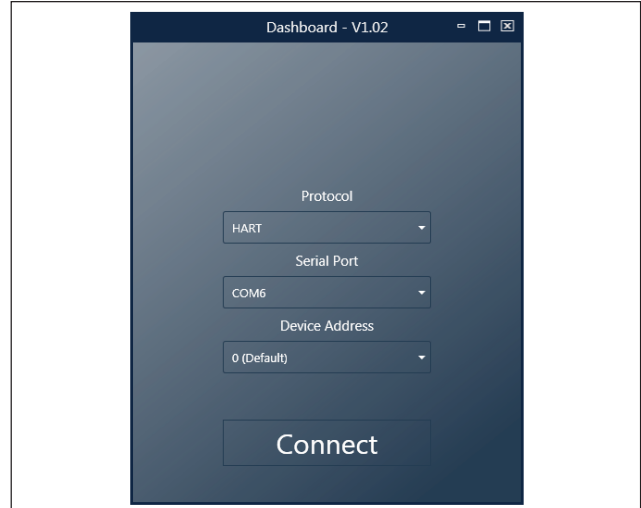

Fig. 3: Initial screen

4. Select COM Port. Software will show active COM ports. Make sure converter is connected before starting Dashboard or COM port will not show.

#### 8.1.2 Home screen

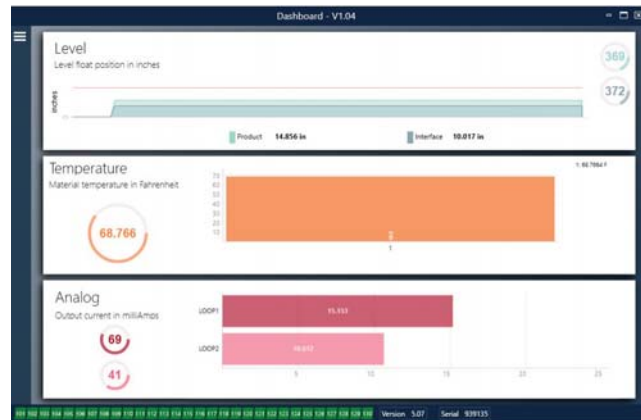

Fig. 4: Home screen

The Dashboard Home Screen will look different based on whether or not temperature has been ordered. If the level transmitter includes temperature measurement then the Home Screen will look as shown. If the level transmitter does not include temperature measurement, then the Home Screen will not show the middle panel for temperature. The Home Screen can be accessed by pressing the three white bars on the top left.

The level panel on top shows the level measurement for the Product level and Interface level. If only the product float is selected then only the product float will be shown. The bold numbers are the numerical level and the graph is a time lapse of the graphical representation of the numbers. The red line is the approximate maximum level based off of the order length of the level transmitter. The numbers on the right of the level panel are the Trigger Level for the Product Float on top and the Interface Float on bottom. These are a representation of how strong of a return signal the level transmitter is experiencing.

The temperature panel will only show if temperature measurement was ordered and turned on. The left side shows the numerical value of temperature. The bar graph in the middle of the panel shows temperature measurement point.

Across the bottom of the Home Screen is the visual indication of the fault codes from section 7. Green indicates no fault and red indicates fault. Next is the firmware version in the middle followed by the serial number.

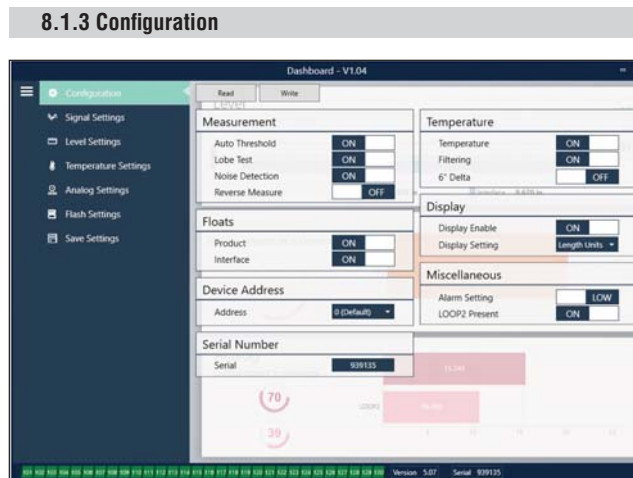

Fig. 5: The Configuration tab allows the level transmitter to be configured for the specific application.

**Factory Set**

**Auto Threshold:** Default setting is ON and should not be turned off. This feature allows the unit to automatically adjust the threshold for optimal performance.

**Lobe Test:** A functional test to make sure the return signal from transmitter has the correct shape. Lobe Test should be on unless unit is a chamber mounted transmitter. Due to special magnet configurations in magnetic level gauge floats, the Lobe Test is turned off on chamber mounted transmitters.

**Noise Detection:** A functional test to determine if noise is entering the level transmitter.

**Product Float:** Default setting of ON for all applications.

**Interface Float:** Default setting of ON if ordering 2 Loops. Default setting of OFF if ordering 1 Loop. If the number of floats turned on is different from the number of floats physically on the level transmitter the level transmitter will go into Fault.

**Serial Number:** Serial Number assigned by factory at the time of manufacture. The serial number is used for tracking and replacement parts. HART® only displays 6 of 8 digits. Do not change.

**Temperature:** Default setting of OFF if ordered without temperature. Default setting of ON if ordered with temperature. Turning temperature ON when the level transmitter was not ordered with temperature will not cause temperature to work and will force the level transmitter into Fault.

**Filtering:** An internal filtering process for the temperature measurement. Filtering should be ON.

**6" Delta:** Internal setting. Leave ON.

**Display Enable:** Default setting of ON. Display can be turned off by changing to OFF and cycling power.

**LOOP2 Present:** Internal flag to turn on Loop 2. Changing this will not allow a second loop unless the hardware was ordered with a second loop.

**User Configurable**

**Reverse Measure:** Allows the end user to change the direction in which the level transmitter counts. The default setting is OFF and the level transmitter will reference the tip of the pipe/hose and count up from the tip. The ON setting will reference the head of the level transmitter and count up as it moves towards the tip.

**Device Address:** The end user can configure the HART® address if being used in a multidrop network. Default address is 0. Do not change from 0 unless all communication will be done via HART® as the current loop will not respond in multidrop mode.

**Display Setting:** Allows the end user to configure the display. Available options are level in engineering units, current (mA), or percentage full. Default setting is level.

**Alarm Setting:** Allows the end user to configure a High (>21 mA) or Low (<3.6 mA) alarm for level transmitter. Default setting is Low (<3.6 mA) alarm.

**8.1.4 Signal settings**

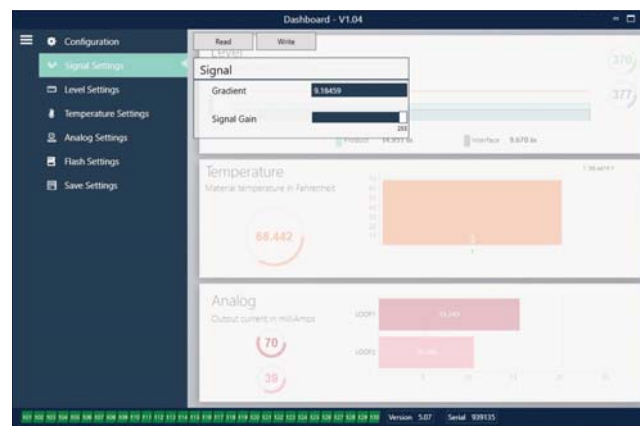

Fig. 6: Signal settings

**Factory Set**

**Gradient:** Is the speed at which the magnetostrictive signals travel

along the sensing element. Typical range is from 8.9 to 9.2. Do not change unless replacing the sensing element. Changing this number will directly affect accuracy.

**Signal Gain:** Is the strength of the interrogation pulse. Factory uses the same electronics for all lengths and adjusts the signal based on the order length. Do not change unless instructed to do so by the Factory.

### 8.1.5 Level settings

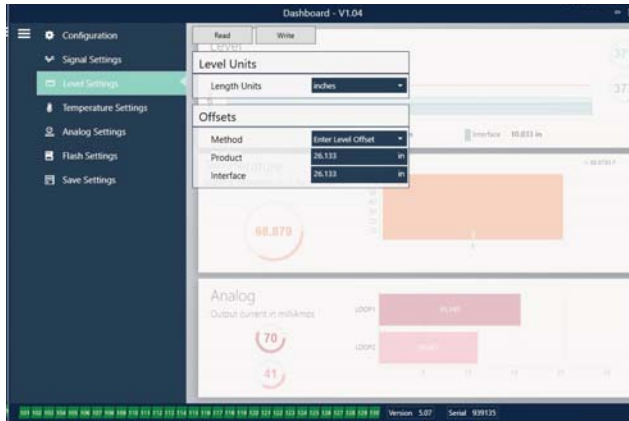

Fig. 7: Level settings

#### Factory Set

**Method – Enter Level Offset:** a calibration method that directly changes the offset of the level measurement. The offset is the zero reference point used in determining the level output. Do not use without Factory guidance.

**Product Offset:** the full length of the level transmitter including order length, inactive zones, and mounting length. Do not change the Enter Level Offset method without Factory guidance. The offset will change after using the Enter Current Tank Level for the Product. The Product Offset and Interface Offset are independent of one another.

**Interface Offset:** the full length of the level transmitter including order length, inactive zones, and mounting length. Do not change the Enter Level Offset method without Factory guidance. The offset will change after using the Enter Current Tank Level for the Interface. The Product Offset and Interface Offset are independent of one another.

#### User Configurable

**Length Units:** the unit of measurement used for engineering units. Default is inches if ordered in inches and mm if ordered in mm. Options include inches, feet, millimeters, centimeters, and meters.

**Method – Enter Current Tank Level:** a calibration method that calibrates the level transmitter based off of one point of measurement. Select Enter Current Tank Level from the Method drop down box. Go to Product Level and enter value of current product level based off of a manual measurement while the tank level is not changing. Go to Interface Level and enter value of current interface level based off of a manual measurement while the tank is not changing. Click Update box in lower left corner when it appears. Level transmitter is now calibrated.

### 8.1.6 Temperature settings

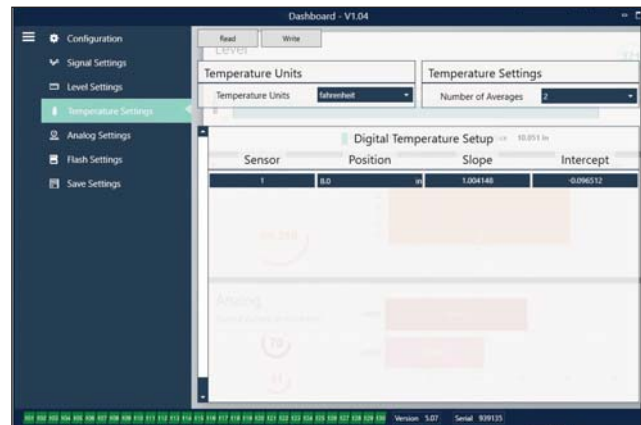

Fig. 8: Temperature settings

#### Factory Set

**Position:** The location of the temperature sensor in reference to the end of the pipe.

**Slope:** Calibration factor for the temperature sensor. Do not change unless a new sensing element with temperature is ordered.

**Intercept:** Calibration factor for the temperature sensor. Do not change unless a new sensing element with temperature is ordered.

#### User Configurable

**Temperature Units:** Change the units of measure for the temperature settings. Options are Fahrenheit or Celsius.

**Number of Averages:** Change the number of temperature readings used in the rolling average.

### 8.1.7 Analog settings

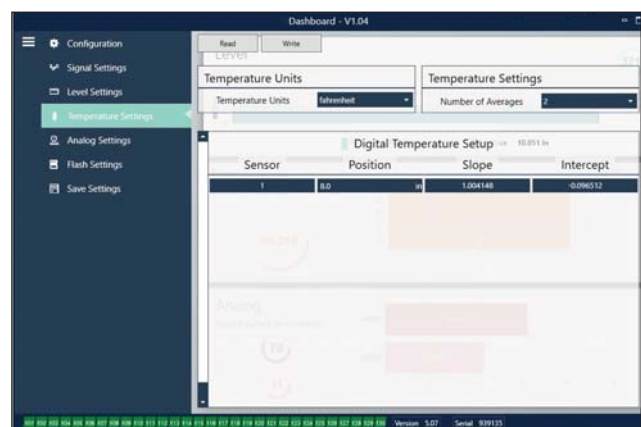

Fig. 9: Analog settings

#### User Configurable

**Product Zero:** Change the Zero (LRV, 4mA) set point of the product level. The set point needs to be in the active range.

**Product Span:** Change the Span (URV, 20mA) set point of the product level. The set point needs to be in the active range.

**Interface Zero:** Change the Zero (LRV, 4mA) set point of the interface level. The set point needs to be in the active range.

**Interface Span:** Change the Span (URV, 20mA) set point of the interface level. The set point needs to be in the active range.

**Temp Zero:** Change the Zero (LRV, 4mA) set point of the temperature. The set point needs to be in the active range. The Temp Zero needs to be less than the Temp Span.

**Temp Span:** Change the Span (URV, 20mA) set point of the temperature. The set point needs to be in the active range. The Temp Zero needs to be less than the Temp Span.

**Product Damping:** Slows the rate of change of the product level. Default setting is 0.4s.

**Interface Damping:** Slows the rate of change of the interface level. Default setting is 0.4s.

**Temp Damping:** Slows the rate of change of the temperature. Default setting is 0.4s.

**PV:** Select the process variable that is used as the PV in HART® and Loop 1 output. Product, Interface, or Temperature can be used.

**SV:** Select the process variable that is used as the SV in HART® and Loop 2 output. Product, Interface, or Temperature can be used. SV can be same as PV.

**TV:** Select the process variable that is used as the TV in HART®. Product, Interface, or Temperature can be used. TV can be the same as SV and/or PV.

### 8.1.8 Flash settings

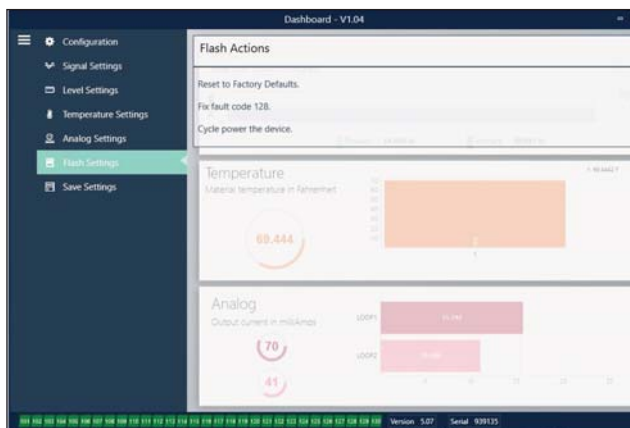

Fig. 10: Flash settings

#### User Configurable

**Reset to Factory Defaults:** Allows the end user to reset all settings back to the original settings as they were when they left the factory. This is intended to be used as a first step in troubleshooting. Do note, the Zero and Span set points will reset to factory settings.

**Fix fault code 128:** If fault code 128 appears red then click the link on the Dashboard to clear the fault.

**Cycle power the device:** Allows the end user to have the level transmitter automatically turn power off, turn power on, and reboot the device.

### 8.1.9 Save settings

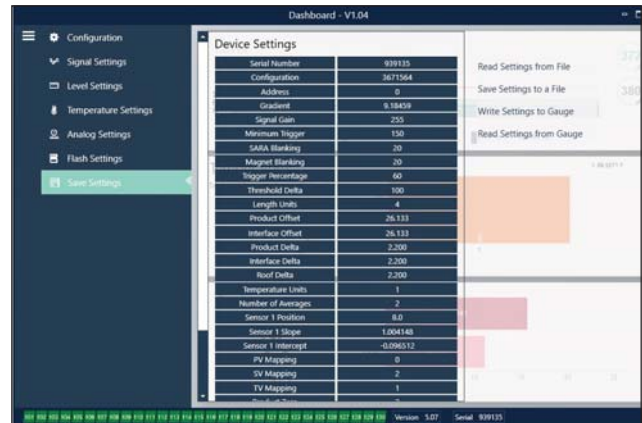

Fig. 11: Save settings

#### User Configurable

**Read Settings from File:** Allows the end user to upload factory parameters from a backup file to the Dashboard. This task is usually performed from a saved backup file or the original backup file maintained by factory.

**Write Setting to a File:** Allows the end user to download a backup file of factory parameters from the Dashboard to a PC. This task is usually performed after Read Settings from Gauge. Note – wait until all settings have changed from Red to White before writing as the color change signals that the settings have been updated.

**Write Settings to Gauge:** Allows the end user to program the level transmitter with the factory parameters displayed on the Dashboard. This task is usually performed after Read Settings from File.

**Read Settings from Gauge:** Allows the end user to update all of the factory parameters displayed on the screen. All settings will turn Red and then will turn white as they are updated.

#### NOTICE

A copy of the backup file is maintained by factory including all factory parameters as the level transmitter was originally setup after completing testing and calibration at the factory. Factory can provide a copy of the backup file upon request based off of the serial number of the level transmitter. Contact Technical Support for assistance.

## 8.2 Handheld Programming

### 8.2.1 Handheld Menu Tree

<b>Device Setup</b>	
↳	Write Protect (Must be disabled to show complete menu tree)
↳	<b>Process Variables</b>
↳	PV
↳	SV
↳	TV
↳	<b>Diag/Service</b>
↳	Test Device
↳	Status
↳	Self Test
↳	Loop Test
↳	4 mA
↳	20 mA
↳	Other
↳	Set Factory Values
↳	Set Data CRC
↳	Power Cycle Device
↳	<b>Basic Setup</b>
↳	Tag
↳	PV Unit
↳	PV LRV
↳	PV URV
↳	PV Damp
↳	Device Information
↳	<b>Detailed Setup</b>
↳	Variable mapping
↳	<b>Configuration</b>
↳	Sys Config
↳	Alarm
↳	Level 1
↳	Level 2
↳	Temperature
↳	Display
↳	Display Setting
↳	Lobe Count
↳	Gradient
↳	<b>Offsets</b>
↳	Float 1 Offset
↳	Float 2 Offset
↳	<b>LCD settings</b>
↳	Screen delay
↳	Screen contrast

↳	<b>Sensors</b>
↳	<b>Level 1</b>
↳	Level 1 Unit
↳	Level 1
↳	Level 1 Class
↳	Level 1 LRV
↳	Level 1 URV
↳	Level 1 Min Span
↳	Level 1 Damp
↳	<b>Level 2</b>
↳	Level 2 Unit
↳	Level 2
↳	Level 2 Class
↳	Level 2 LRV
↳	Level 2 URV
↳	Level 2 Min Span
↳	Level 2 Damp
↳	<b>Temp</b>
↳	Temp Unit
↳	Temp
↳	Temp Class
↳	Temp LRV
↳	Temp URV
↳	Temp Min Span
↳	Temp Damp
↳	<b>HART output</b>
↳	Poll addr
↳	Num reg preams
↳	Device Information
↳	<b>Review</b>
	<b>PV</b>
	<b>PV Loop Current</b>
	<b>PV LVR</b>
	<b>PL URV</b>

8.2.2 Handheld Menu Screenshots

8.2.2.1 Online Menu Screen

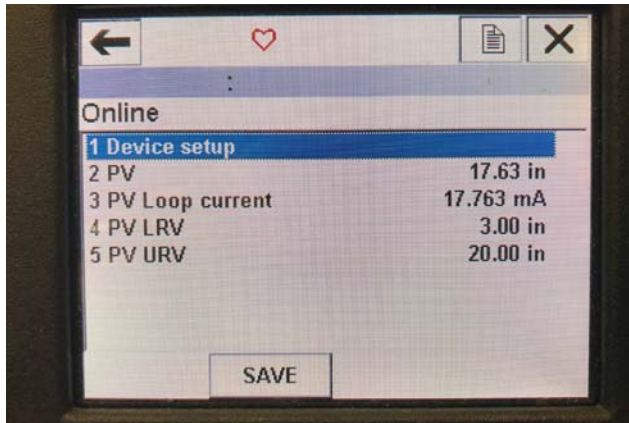

Fig. 12: Online Screen

**Parameters**

No Editable Parameters

**Data**

PV, PV Loop current, PV LRV, and PV URV are all shown on screen

8.2.2.2 Device setup Menu Screen

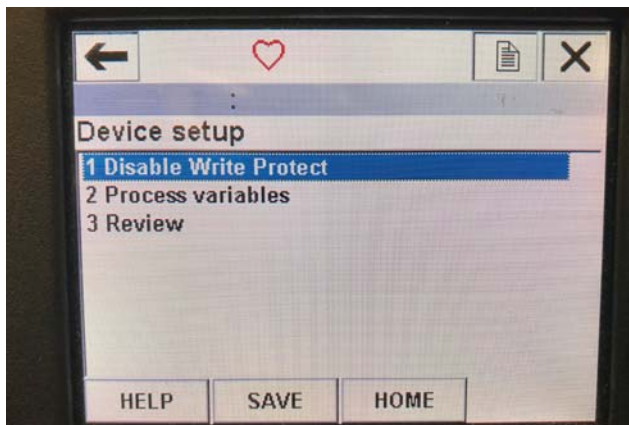

Fig. 13: Write Protect Enabled Screen

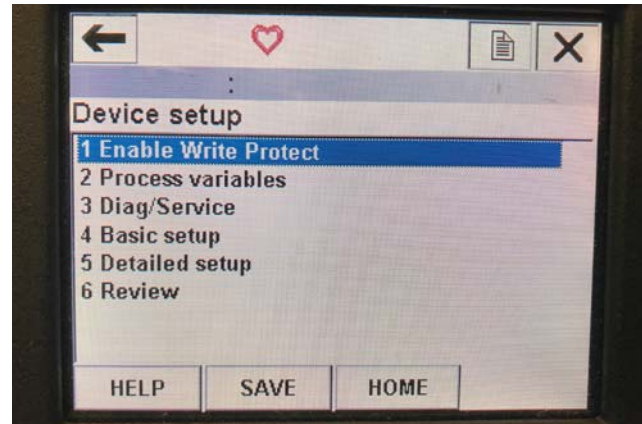

Fig. 14: Write Protect Disabled

**Parameters**

Write Protect - user can turn disable or enable write protect mode. While write protect is enabled, no variables can be changed and the full menu tree cannot be seen.

**Data**

No Data is displayed

8.2.2.3 Process variables Menu Screen

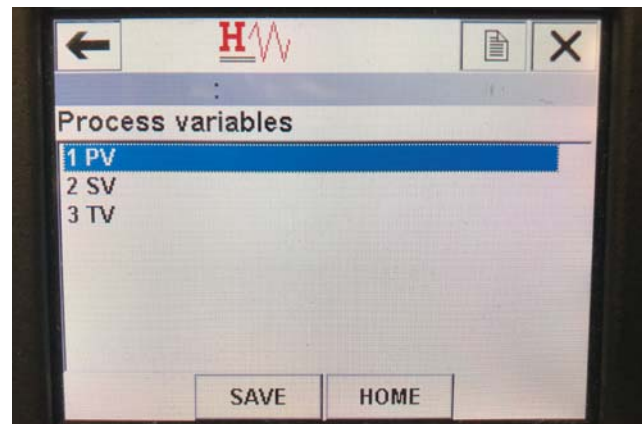

Fig. 15: Process Variable Screen

**Parameters**

**PV** – Primary Variable is the HART® parameter that is by default mapped to the Product Level. This can be changed using Variable mapping feature. SIL2 Capable units do not allow the PV to be changed.

**SV** – Secondary Variable is the HART® parameter that is mapped to the Interface Level unless Temperature is ordered. This can be changed using the Variable mapping feature.

**TV** – Tertiary Variable is the HART® parameter that is mapped to the Temperature by default. This can be changed using the Variable mapping feature.

**Data**

No Data is displayed

8.2.2.4 PV Menu Tree

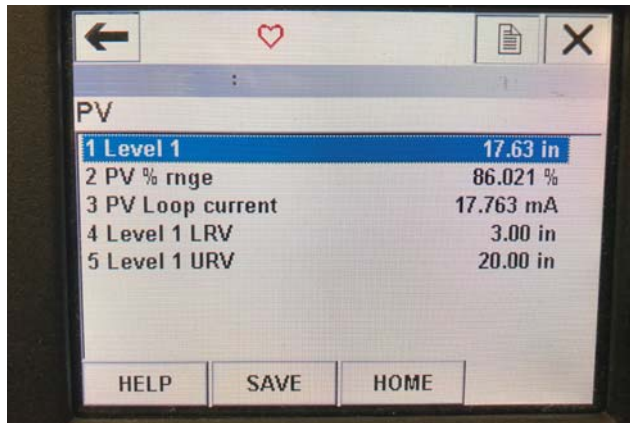

Fig. 16: PV Menu Tree

Parameters

**Level 1 LRV** – lower range value of the PV that correlates to the location of the 4 mA set point of the output.

**Level 1 URV** – upper range value of the PV that correlates to the location of the 20 mA set point of the output.

Data

**Level 1** – the product level is displayed.

**PV% range** – the percentage (0 to 100%) of the active range that the process variable is currently at.

**PV Loop current** – the current output level of the PV based on the settings of the LRV, URV, and Level 1

8.2.2.5 SV Menu Tree

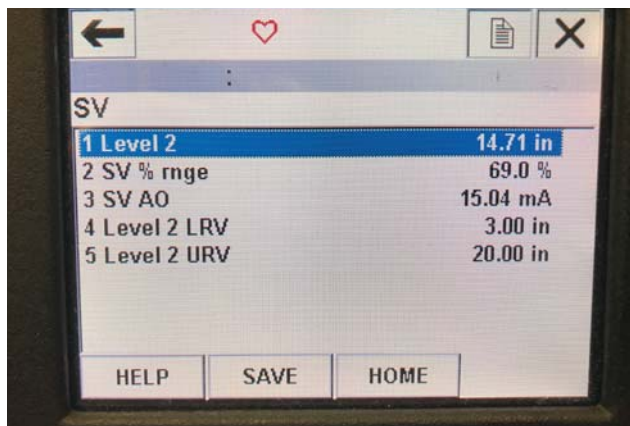

Fig. 17: SV Menu Tree

Parameters

**Level 2 LRV** – lower range value of the SV that correlates to the location of the 4 mA set point of the output.

**Level 2 URV** – upper range value of the SV that correlates to the location of the 20 mA set point of the output.

Data

**Level 2** – the interface level is displayed.

**SV% range** – the percentage (0 to 100%) of the active range that the process variable is currently at.

**SV Loop current** – the current output level of the SV based on the settings of the LRV, URV, and Level 2.

8.2.2.6 TV Menu Screen



Fig. 18: TV Menu Tree

Parameters

**Temp LRV** – lower range value of the TV that correlates to the location of the 4 mA set point of the output.

**Temp URV** – upper range value of the TV that correlates to the location of the 20 mA set point of the output.

Data

**Temp** – the temperature is displayed.

8.2.2.7 Diag/Service Menu Screen

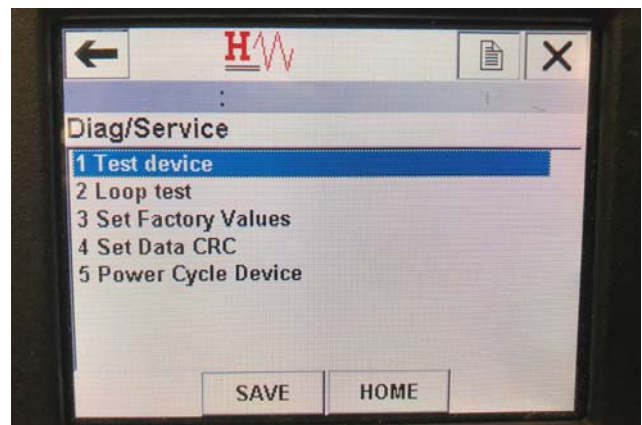

Fig. 19: Diag/Service Menu Screen

Parameters

**Set Factory Values** – clears all programming and resets factory parameters to default values. Do not perform this function unless instructed to do so by factory technical support.

**Set Data CRC** – allows the user to rest the CRC in the level transmitter and clear the 128 Fault Code.

**Power Cycle Device** – allows the user to power cycle the level transmitter without disconnecting power from the unit.

Data

No Data is Displayed

8.2.2.8 Test device Menu Screen

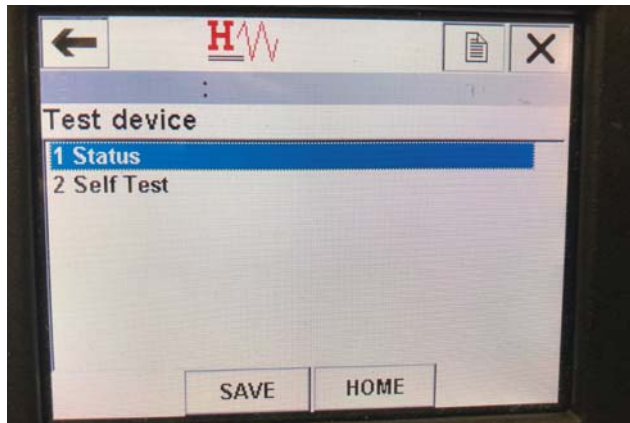

Fig. 20: Test Device Menu Screen

**Parameters**

**Self Test** – allows user to force level transmitter to check for fault codes. Fault codes would be displayed under Status.

**Data**

**Status** – shows any existing fault codes

8.2.2.9 Status Menu Screen

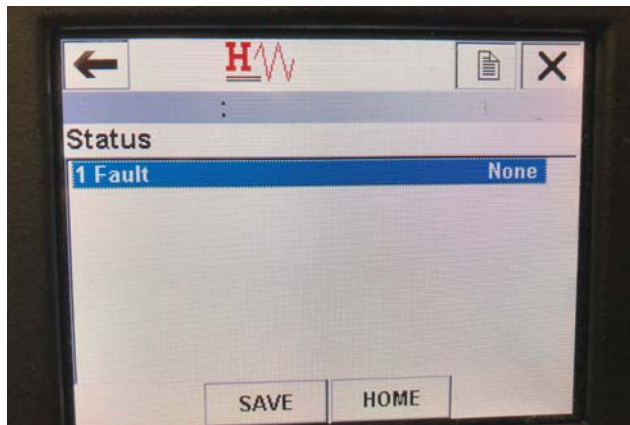

Fig. 21: Status Menu Screen

**Parameters**

No editable parameters

**Data**

**Fault** – shows fault codes displayed by level transmitter. These codes are explained in section 7. User must run Self Test before fault codes will appear.

8.2.2.10 Loop Test Menu Tree

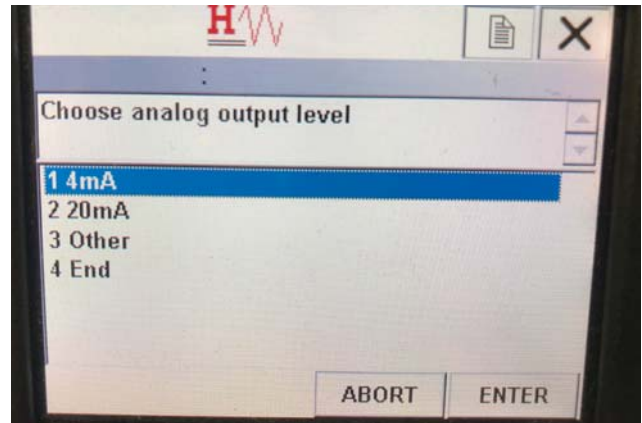

Fig. 22: Loop Test Menu Tree

**Parameters**

**4 mA** – allows the user to force loop test and current output to 4 mA

**20 mA** – allows the user to force loop test and current output to 20 mA

**Other** – allows the user to force loop test and current output to selected level

**End** – Stops loop test and returns level transmitter to normal output

**Data**

No data is displayed

8.2.2.11 Basic setup Menu Screen

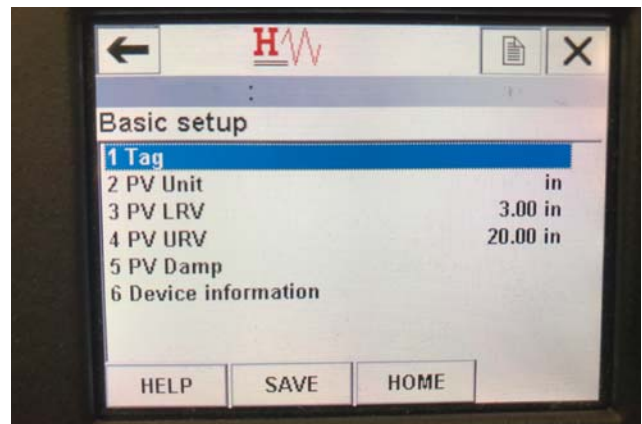

Fig. 23: Basic Setup Menu Screen

**Parameters**

**Tag** – HART® descriptor that can be edited by user

**PV Unit** – unit of measure for the PV variable

**PV LRV** – lower range value of the PV that correlates to the location of the 4 mA set point of the output.

**PV URV** – upper range value of the PV that correlates to the location of the 20 mA set point of the output.

**PV Damp** – allows the user to select the damping of the PV variable

**Data**

**Device Information** – provide detailed information on the setup of the PV



8.2.2.12 Detailed setup Menu Screen



Fig. 24: Detailed Setup Menu Screen

**Parameters**

**Variable mapping** – allows the user to select the factory variables that are mapped to the PV, SV, and TV

**Configuration** – allows access to several factory parameters

**Offsets** – allows access to calibrating the level transmitter

**LCD settings** – allows access to customizing LCD display

**Sensors** – allows access to data and programming of PV, SV, and TV

**HART output** – allows access to setting HART® multidrop network

**Data**

**Device Information** – provide detailed information on the setup of the PV

8.2.2.13 Variable mapping Menu Screen

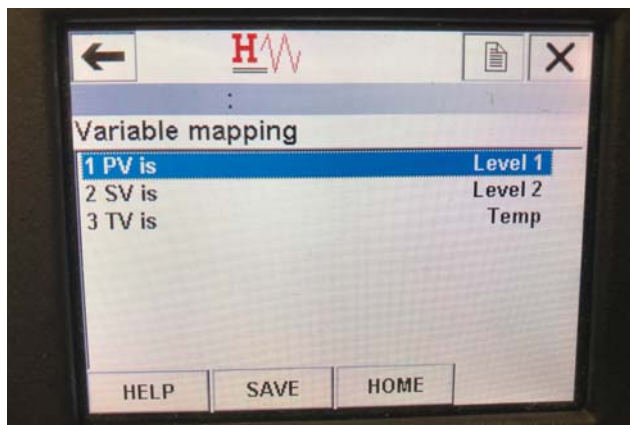

Fig. 25: Variable Mapping Menu Screen

**Parameters**

**PV is** – allows user to select the factory variable that is mapped to the PV in HART®

**SV is** – allows user to select the factory variable that is mapped to the SV in HART®

**TV is** – allows user to select the factory variable that is mapped to the TV in HART®

**Data**

No data is displayed

8.2.2.14 Configuration Menu Screen

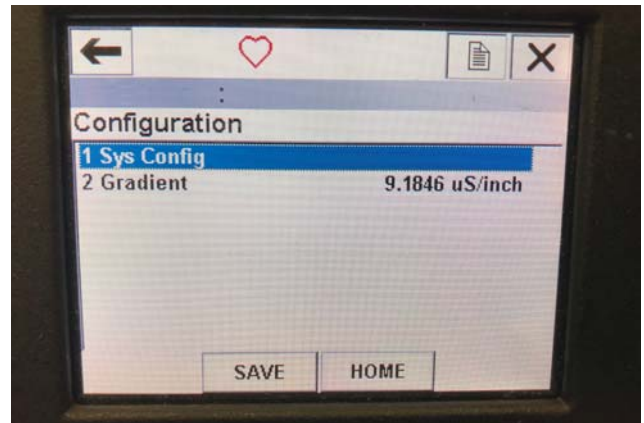

Fig. 26: Configuration Menu Screen

**Parameters**

**Sys Config** – allows access to factory parameters

**Gradient** – calibration factor for level transmitter that should not be changed unless replacing a sensing element.

**Data**

No data is displayed

8.2.2.15 Sys Config Menu Screen

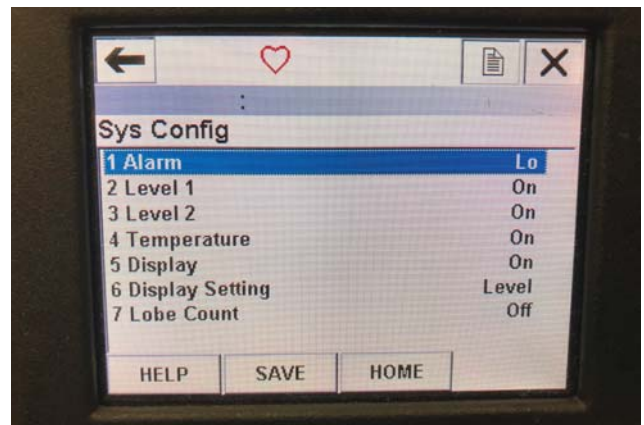

Fig. 27: Sys Config Menu Screen

**Parameters**

**Alarm** – allows user to select between a Hi (>21 mA) and Lo (<3.6 mA) alarm setting. Default is a low alarm.

**Level 1** – allows user to turn product level on or off. Should always be on.

**Level 2** – allows user to turn interface level on or off. This will not work if a second float is not used.

**Temperature** – allows user to turn temperature on or off. This will not work unless temperature is ordered on the level transmitter.

**Display** – allows the user to turn the display on or off. Power must be cycled for this to take affect.

**Display Setting** – allows the user to select if the display shows Level, mA, or %. Default setting is Level.

**Lobe Count** – allows the user to turn the lobe fault on or off. The lobe count should be on unless unit is a chamber mounted transmitter.

**Data**

No data is displayed

**8.2.2.16 Offsets Menu Screen**



Fig. 28: Offsets Menu Screen

**Parameters**

**Float 1 Offset** – allows user to change the offset of the product level that is used for calibration. Please contact the factory for technical support to make this change.

**Float 2 Offset** – allows user to change the offset of the interface level that is used for calibration. Please contact the factory for technical support to make this change.

**Data**

No data is displayed

**8.2.2.17 LCD settings Menu Screen**

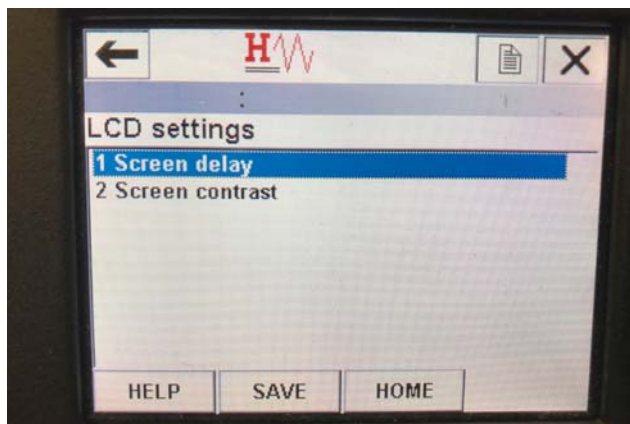

Fig. 29: LCD Settings Menu Screen

**Parameters**

**Screen delay** – allows user to change the update rate of the display. This should not be adjusted without factory support.

**Screen contrast** – allows user to change the darkness of the display.

**Data**

No data is displayed

**8.2.2.18 Sensors Menu Screen**

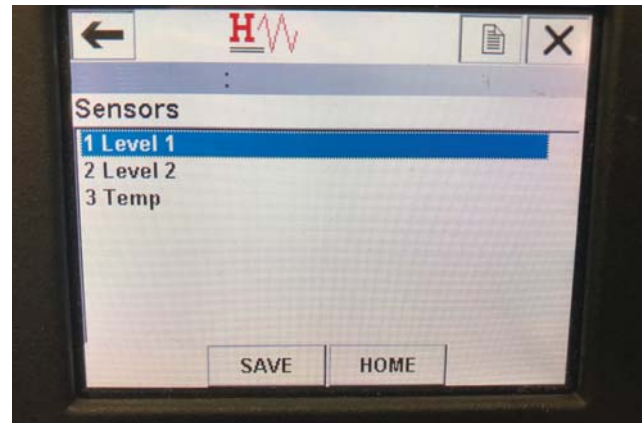

Fig. 30: Sensors Menu Screen

**Parameters**

**Level 1** – allows user to access parameters and data for product level.

**Level 2** – allows user to access parameters and data for interface level.

**Temp** – allows user to access parameters and data for temperature.

**Data**

No data is displayed

### 8.2.2.19 Level 1 Menu Screen

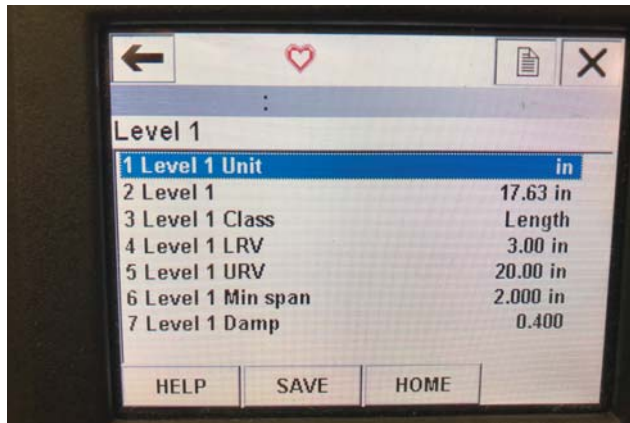

Fig. 31: Level 1 Menu Screen

#### Parameters

**Level 1 Unit** – allows user to change unit of measure for product level.

**Level 1 LRV** – lower range value of the product level that correlates to the location of the 4 mA set point of the output.

**Level 1 URV** – upper range value of the product level that correlates to the location of the 20 mA set point of the output.

**Level 1 Damp** – damping parameter for product level

#### Data

**Level 1** – actual product level in units of measure

**Level 1 Class** – variable class for product level

**Level 1 Min span** – the minimum distance required between the Level 1 LRV and Level 1 URV

### 8.2.2.20 Level 2 Menu Screen

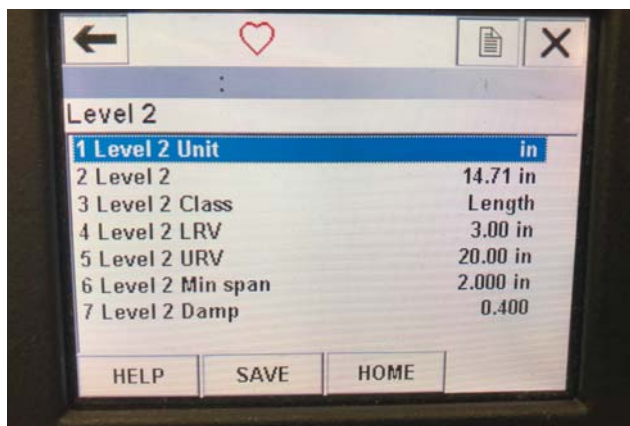

Fig. 32: Level 2 Menu Screen

#### Parameters

**Level 2 Unit** – allows user to change unit of measure for product level.

**Level 2 LRV** – lower range value of the interface level that correlates to the location of the 4 mA set point of the output.

**Level 2 URV** – upper range value of the interface level that correlates to the location of the 20 mA set point of the output.

**Level 2 Damp** – damping parameter for interface level

#### Data

**Level 2** – actual product level in units of measure

**Level 2 Class** – variable class for interface level

**Level 2 Min span** – the minimum distance required between the Level 2 LRV and Level 2 URV

### 8.2.2.21 Temp Menu Screen

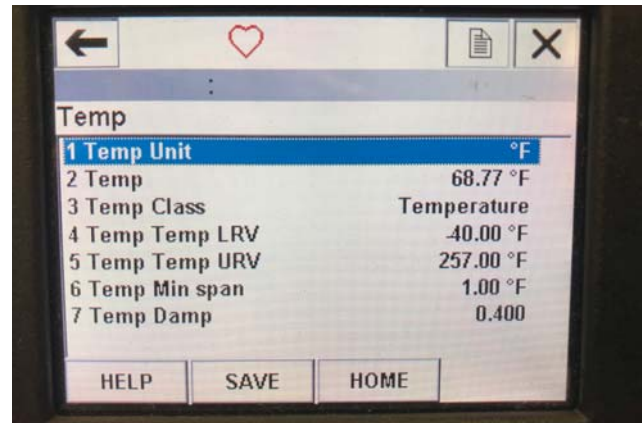

Fig. 33: Temp Menu Screen

#### Parameters

**Temp Unit** – allows user to change unit of measure for temperature.

**Temp LRV** – lower range value of the temperature that correlates to the location of the 4 mA set point of the output.

**Temp URV** – upper range value of the temperature that correlates to the location of the 20 mA set point of the output.

**Temp Damp** – damping parameter for temperature

#### Data

**Temp** – actual temperature in units of measure

**Temp Class** – variable class for temperature

**Temp Min span** – the minimum distance required between the Temp LRV and Temp URV

### 8.2.2.22 HART® output Menu Screen

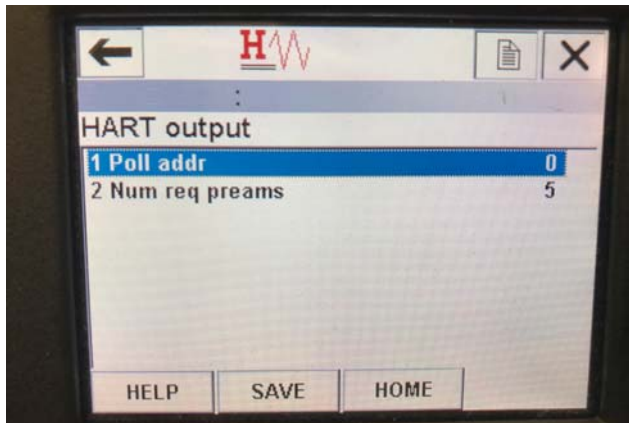

Fig. 34: HART output Menu Screen

#### Parameter

**Poll addr** – allows user to change polling address of HART® device. Unless using HART® in multidrop network do not change Poll addr from default value of 0.

**Num req preams** – changes the HART® preamble. Do not adjust.

#### Data

No data displayed